

## INTRIGO 800 SOUS PLAN

Kitchen Sinks

Code: N458 S40

VASCA INTRIGO mm 800x400 R12 SOUSPLAN

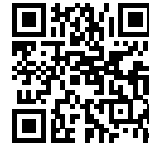

### DETAILS

Edge/Installation Type	Undermount
Material	AISI 304 stainless steel
Texture	Foster brushed
Base	90 cm
Dimensions	840x440 mm
Standard fittings	Fixing hooks, gasket, drain, overflow and siphon, boxed packing
Mixer holes	No standard holes
Built-in hole	View technical data sheet
Drainer	No

Width 84 cm

---

Bowl dimension 800x400mm

---

Number of bowls 1 bowl

---

Waste fitting Drain SPACE 3,5"

---

Notes: As the product consists of a single seamless steel surface with no gaps or interstices, the use of garbage disposal and waste fitting with automatic control is not permitted.

---

## FEATURES

**ONE SEAMLESS STEEL SURFACE** The waste-fitting and overflow are moulded on the sink. The product is therefore made out of one seamless steel surface, without gaps or interstices. A great plus in terms of hygiene.

---

**Deep bowls** This bowls reach an important depth, over 20 cm, thanks to the advanced production technology, that can be offer great capiciency and practicity in all the washing operations.

---

**High thickness** 1mm thick steel. A significant thickness, which guarantees the maximum sturdiness and durability.

---

**Perimetral overflow** The overflow is always a security on the Foster sinks that prevents the overflow of water in case of oversights. The perimeter drain solution improves aesthetics thanks to its square and essential shape.

---

**Save space system** Drain and siphon are designed to leave as much space as possible in the under-sink area, more and more useful today for theseparate waste collection systems.

---

**Small radius** Bowls with squared shapes with a modern design and an increased capacity, for a minimal aesthetics connected with an extreme practicity.

---

**Space waste fitting** The elegant SPACE steel cap closes the drain and leaves no visible residues collected in the basket below. Space also has a small footprint and allows the optimal use of the under-sink compartment.

---

## TECHNICAL DATA

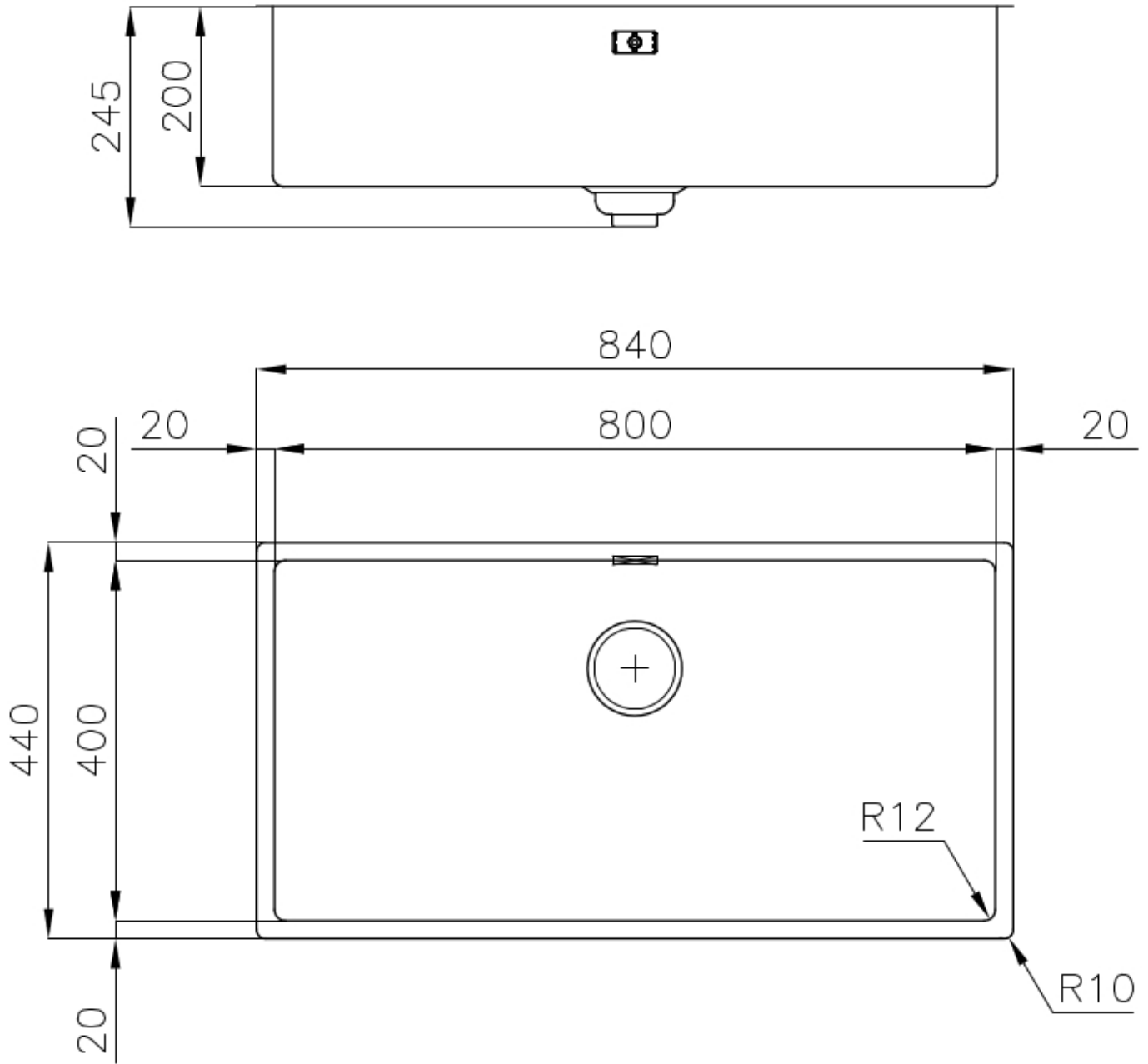

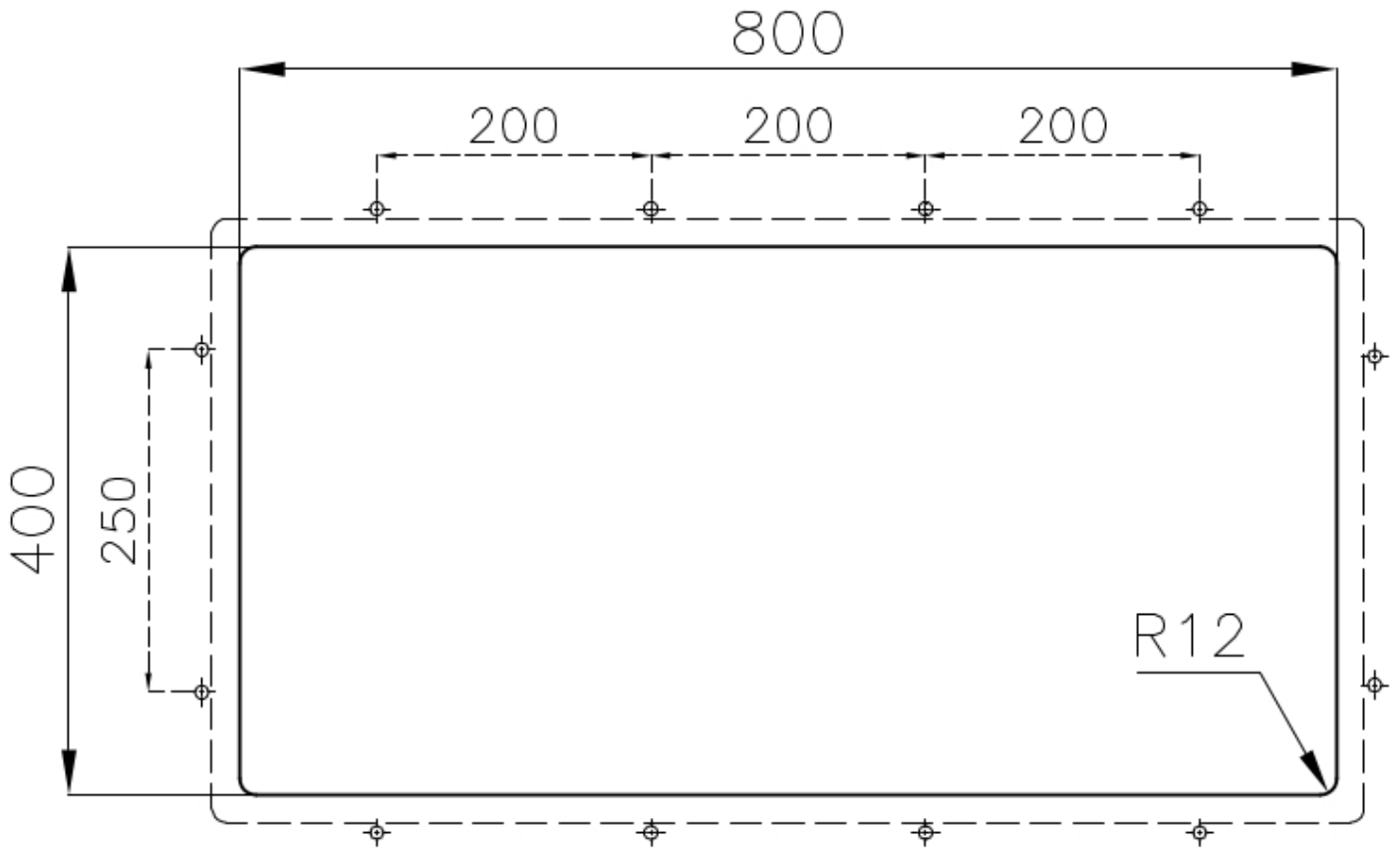

## GALLERY



## OPTIONAL ACCESSORIES



**CUVETTE PERFOREE INOX**

A154 F00

\* only in combination with the accessory  
A644 F04



**CUVETTE PLASTIQUE BLANCHE**

A153 A00

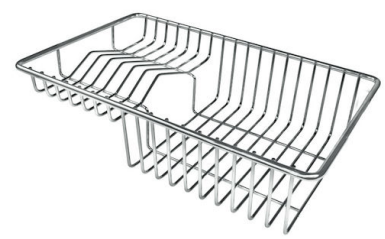

**GRILLE POR.ASSIETTES INOX**

**mm214x379**

A100 C03

\* only in combination with the accessory  
A644 A01



**GRILLE PORTE-ASSIETTES INOX**

**250x425**

A100 B01



**GRILLE PORTE-ASSIETTES INOX**

**25x35**

A100 A54

\* only in combination with the accessory  
A644 F04



**PLANCHE DE DECOUPE CRYSTAL**

**23x41 CM**

A631 C00



**PLANCHE DE DECOUPE DOUBLE  
HDPE**  
A644 A01



**PLANCHE DE DECOUPE DOUBLE  
IROKO**  
A644 F04



**CUVETTE INOX PERFOREE**  
A151 F00  
\* only in combination with the accessory  
A644 A01



**KIT RÂPES ET PLANCHE DE  
DECOUPE HDPE**  
A159 A01  
\* only in combination with the accessory  
A644 A01



**PANIER INOX POUR CUVE 34x40  
CM**  
A611 F00



**PLANCHE DE DECOUPE DOUBLE  
IROKO**  
A644 F44

## RECOMMENDED PAIRINGS



**INCISO**  
R424 A00